

SOLAR & ELECTRIC MOBILITY
INNOVATIONS

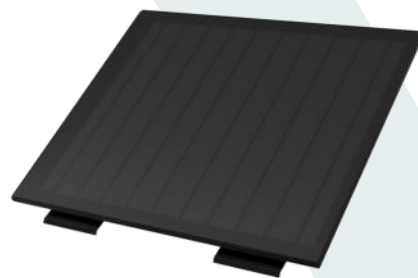

paXos



TABLE OF CONTENTS

Foreword	5
Solar	6
Multi Energy Roof: Solar Plain Tile.....	6
Multi Energy Roof: Solar Beaver Tail	8
Solar Roof Tile Mild-Hybrid	10
Solar Roof Tile Accessories.....	12
Solar Facade Element Mild-Hybrid.....	14
Solar Water Element	16
Solar Agricultural Element Foundation System.....	18
Solar Traffic Route Element.....	20
Solar Automotive Integration	22
Junction Box PV.....	24
Electric Mobility	26
High Performance Charging System	26
Cable Bridge.....	29
Charging Device Automated.....	30
Charging Pole Small.....	32
Charging Pole Tall.....	34
Wheel Hub Motor Axial Suspended.....	36
Mounting System	38
Rapid Foundation System.....	38
Company	40
Services	41
Consulting	41
Think Tank.....	41
Engineering	42
Project Management	42
Training.....	43
HR Consulting	43
Journey Description	44
Notes	45
Imprint	46

> FOREWORD

Dear Reader,

The world today is full of challenges.

Climate change demands significant reduction of CO₂ emissions. High population pressure demands the best utilization of land for food and energy production. Finite resources (fossil fuels / clean air to breath / land) demand careful usage of these resources.

paXos innovates and develops solutions to overcome these challenges. We are a “think tank” focusing on cleantech: sustainable energy production, practicability of e-mobility and the best utilization of resources and land.

Our motivation is to create the best future for mankind. Our easy-to-use scalable solutions with their proven business cases have the potential to reach many end users.

In this brochure you will find an extract of cleantech solutions - some of them will shortly go into high volume production and others are ideas waiting to unfold.

We are looking for you - dear investor, production partner, sales partner and end user to move with us from concept to production.

Together we can make the world a better place.

The paXos associates



From left to right:

- > [Karsten Birkholz](#)
- > [Janina Kaergel](#)
- > [Peter Hakenberg](#)
- > [Stefan Puczynski](#)
- > [Guido Schumacher](#)



MULTI ENERGY ROOF: SOLAR PLAIN TILE



With the Multi Energy Roof developed by paXos, it is possible to use photovoltaics and solar thermal energy in combination with an attractive, inconspicuous appearance.

A conventional trapezoidal sheet metal serves as a substructure, on which solar roof tiles of various designs can be easily and quickly installed. The Solar Plain Tile is one possible design variant.

REASONS FOR THE DEVELOPMENT

The visually flawless integration into a wide variety of roof surfaces is only possible to a limited extent with conventional solar modules. The Solar Plain Tile offers the look of the asphalt roof shingles mainly used in the U.S., but in combination with the benefits of PV and solar thermal energy. Different color variants of the Solar Plain Tile offer a large number of possibilities to inconspicuously integrate the tiles into the roof surface.

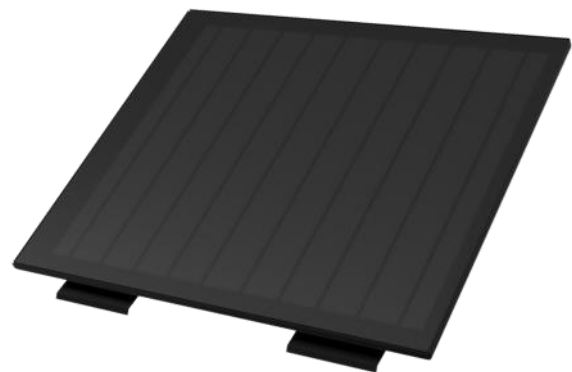

- › Appearance resembles conventional roof shingles
- › Hybrid system for electrical and thermal energy generation
- › Integrated rear ventilation for high performance and durability
- › Optimal use of the entire roof surface for energy generation, partial roofing is also possible

SOLUTION

An individual design of the roof is possible due to the small product dimensions compared to conventional PV modules. Thus, the entire roof or only optimal areas (shading, orientation, etc.) can be covered.

The PV module is a so-called glass-glass module, which has an extremely high resistance to external loads (storm / hail). The two glass panes are hermetically sealed with a butyl edge bonding. This prevents moisture from affecting the cells, which would lead to steadily increasing performance losses.

The design is rounded off by an aluminum frame in which the glass package is enclosed. The frame is powder coated for excellent UV and corrosion protection. In addition, the slightly overlapping frame protects the corners and edges of the glass package.

PROMISES

- › **Performance:** Due to the rear-ventilation system, we can promise high performance of electrical energy over a period of 50 years, and for thermal energy even for a lifetime.
- › **Mechanics:** Our products are certified in terms of hail impact, storm suction and walkability of the roof.
- › **Quality and Durability:** The Multi Energy Roof remains watertight for 200 years and the glass-glass construction with butyl sealing ensures the longevity of the PV module.
- › **Installation:** Our modules are easy to lay, connect and exchange.
- › **Environment:** Our focus lies on the sustainability of our products. We increase the useful life and offer very good recyclability.

ADVANTAGES

Through the trapezoidal sheet as a substructure, defined air channels are formed, which allow rear ventilation and thus cooling of the Solar Plain Tile. At the same time, the warm exhaust air can be used as thermal energy by means of a heat pump. The Multi Energy Roof also provides a rainproof and fireproof sub-roof.

The Solar Plain Tile is mounted horizontally or vertically via integrated hooks on the profile frame, which enable quick assembly as well as disassembly of individual tiles and also act as a metallic conductor for potential equalization.

TECHNICAL DATA

Parameter	SPT Horizontal (H)/ Vertical (V)*	
Color	Black, Blue, Terracotta	
Dimensions (L x W x H) [mm]	378 x 544 x 8.7 (H) 543 x 374 x 8.7 (V)	
Clearance Dimensions [mm]	355 x 544 (H) 520 x 374 (V)	
Junction Box	79 x 24 x 13 IP68	
Cable	4mm ² , 0.25m	
Connector	GZX 1500	
Mass	4.5kg (H) / 4.4 (V)	
Wafer	Monocrystalline, PERC	
Open-Circuit Voltage	4.1 (H) 2.7 (V)	V
Short Circuit Current	9.5 (H) 14.3 (V)	A
Nominal Voltage (U _{mpp})	3.4 (H) 2.2 (V)	V
Nominal Current (I _{mpp})	9.1 (H) 13.6 (V)	A
Rated Output (P _{mpp})	30.8 (H) 29.4 (V)	W
Power Density	159.4 (H) 155.6 (V)	W/m ²

* Specifications each for black design

MULTI ENERGY ROOF: SOLAR BEAVER TAIL

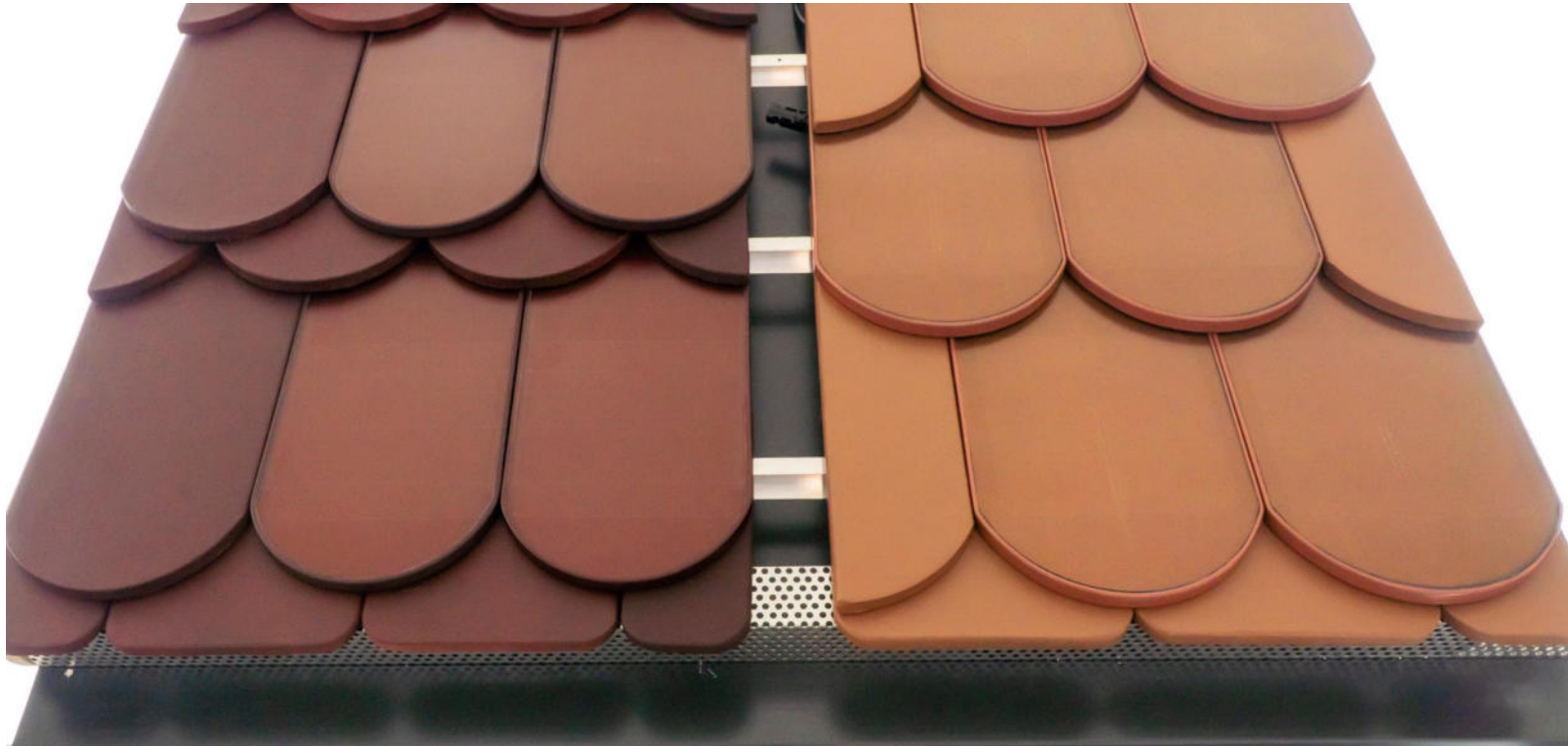

For a classic roofing in the style of the beaver tail, the Solar Beaver Tail was developed. As a building-integrated photovoltaic module, it has the same appearance as conventional beaver tail tiles. This allows even buildings with listed structures to be used for energy generation (photovoltaics and solar thermal) in a stylish way.

IDEA

The widespread use of beaver tail tiles in Southern and Eastern Europe has led to a high demand for this product. Since there are increasing requirements for the protection of monuments on classic roofs, a major part of the development is based on the inconspicuous integration into the roof surface. This also includes the implementation of different color shades and multiple designs.



- › Building-integrated photovoltaic module (BiPV) with different colors
- › Multi Energy Roof for electrical and thermal energy generation
- › Different roofing possible (single, double and crown roofing)
- › Roofing of historic and listed buildings
- › Easy installation and removal of a single SBT from the compound

FEATURES

Historic and listed buildings can be covered with the Solar Beaver Tail (SBT) during roof renovation. In addition, several designs and colors are provided to consider regional requirements or wishes. Further product advantages lie in the simple laying and installation of the SBT, which can be disassembled individually from the composite.

For an efficient dual use of the surface (PV and solar thermal), there is an integrated rear ventilation, which is realized via a trapezoidal sheet as a substructure and allows cooling of the solar cells. This significantly increases the service life of the entire system.

PROMISES

- › **Performance:** Due to back venting, we can promise high performance of electrical energy over a period of 50 years, and for thermal energy even for a lifetime.
- › **Mechanics:** We ensure high hail and storm suction resistance as well as walkability of the roof.
- › **Quality and Durability:** The Multi Energy Roof remains watertight for 200 years, and the glass-glass construction with butyl sealant provides long-term performance of over 50 years.
- › **Installation:** The dimensions of the SBT are identical to the classic 400 x 200mm or the 380 x 180mm beaver tail tile. This makes the module easy to install, connect and replace.
- › **Environment:** Our focus lies on the sustainability of our products. We increase the useful life and offer very good recyclability.
- › **Additional Benefits:** The storm suction protection is already integrated in each SBT. A

black switching capability leads to an increase in fire protection.

TYPES OF ROOFING

The roofing of the SBT can be done as single roofing, classic double roofing or crown roofing. With the single roofing, the highest power density can be achieved at the lowest system cost.



TECHNICAL DATA

Parameter	SBT 200 / SBT 180*	
Color	Brown, Black, Terracotta	
Dimensions (L x W x H) [mm]	400 x 200 x 14 380 x 180 x 12	
Junction Box	IP68 incl. Bypass Diode	
Cable	4mm ² , 0.25m	
Mass	1.5kg / 1.2kg	
Wafer	Monocrystalline, PERC	
Open-Circuit Voltage	1.34 / 0.67	V
Short Circuit Current	7.16 / 10.09	A
Nominal Voltage (U _{mpp})	1.09 / 0.49	V
Nominal Current (I _{mpp})	6.87 / 9.68	A
Rated Output (P _{mpp})	7.5 / 4.7	W
Power Density	113 / 97.1	W/m ²

* Specifications for brown design with single covering and lath spacing of 330mm (SBT 200) or 270mm (SBT 180)

SOLAR ROOF TILE MILD-HYBRID



A stylish integration of the energy revolution into our everyday life, combined with a high-power density and an improved concept in partial shadowing can be found in the Solar Roof Tile Mild-Hybrid.

In addition to electrical energy, the hybrid system also generates thermal energy that can be used for heating or hot water preparation. The building-integrated photovoltaic system sits inconspicuously on the roof, eliminating the need for double roofing.

SALE TO MEYER BURGER

We are very proud to announce that Meyer Burger has acquired the rights to our Solar Roof Tile Mild-Hybrid and is now taking care of industrialization and sales.

For further questions and information, please contact the Meyer Burger sales team directly:

tiles-germany@meyerburger.com



- › Building-integrated, monocrystalline photovoltaic module (BiPV)
- › Hybrid system for electrical and thermal energy generation
- › Optimal utilization of the entire roof surface for energy generation
- › Roofing of listed buildings
- › Integrated rear venting for high performance and durability

REASONS FOR DEVELOPMENT

The space available for solar energy is currently mostly limited to rural regions or suburbs, where large PV modules can be installed or mounted without shading. In large cities, the problem is crystallizing that there are increasingly jagged roof surfaces that cannot be developed with PV modules.

SOLUTION

The Solar Roof Tile Mild-Hybrid is a building-integrated photovoltaic system that has the appearance of a conventional roof.

In addition, the entire roof can be used to generate energy, as the system is small-sized and can be customized. Shading is minimized by intelligent interconnection and protection, which increases the overall yield.

PROMISES

- › **Performance:** Due to back venting, we can promise high performance of electrical and thermal energy over a period of 50 years.
- › **Mechanics:** We have certified our products against hail, storm suction and walkability of the roof.
- › **Quality and Durability:** Due to the glass-glass construction method, the roof remains watertight for 200 years and has a long-term performance with over 50 years.
- › **Installation:** Our modules are easy to lay, connect and exchange.
- › **Environment:** Our focus lies on the sustainability of our products. We increase the useful life and offer very good recyclability.
- › **Additional Benefits:** Matching complementary system available (p. 12), in case of snow and dew on the roof surface, the mod-

ules can be thawed, mounting aids facilitate access to the roof surface and increased fire protection via black switchability.

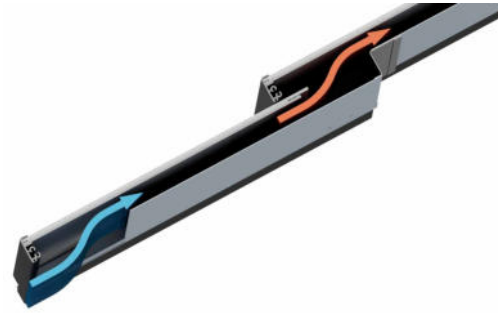

Figure: Cool air warms up as it passes through

ADVANTAGES

There is direct access to all major components via sliding glass packs. This makes it easy to replace any module while the roof is covered.

Thermal degradation no longer takes place due to cooling of the glass package. In addition, the heat at the ridge can be made usable via a heat pump.

TECHNICAL DATA

Parameter	SRT-MH*	
Color	Black, Blue, Terracotta	
Dimensions (L x W x H) [mm]	468 x 331.5 x 30.8	
Clearance Dimensions [mm]	340 x 300 x 30.8	
Junction Box	67 x 75 x 15.7 IP67	
Cable	4mm ² , 0.47m	
Connector	PV4-S	
Mass	2.5kg	
Wafer	Monocrystalline, PERC	
Open-Circuit Voltage	5.3	V
Short Circuit Current	3.5	A
Nominal Voltage (U _{mpp})	4.5	V
Nominal Current (I _{mpp})	3.3	A
Rated Output (P _{mpp})	14.5	W
Power Density	145	W/m ²

* Specifications for black design

SOLAR ROOF TILE ACCESSORIES



In addition to the development of the hybrid modules, we also offer the complementary accessories that can be used for complete roofing.

COMPLEMENTARY SYSTEM

Suitable complementary systems to the SRT-MH are available. Neutral traditional flat roof tiles with standard dimensions of 420 x 330 mm can be used, whose dimensions are identical to the SRT-MH.

- › **Ideal addition to the SRT-MH**
- › **Similar appearance**
- › **No need to cover the entire roof surface**

In the visible area of the roof surface, no differences are apparent in this respect. The visual difference is reduced to a minimum. All roof systems offer the same connections, so that installation can take place immediately.

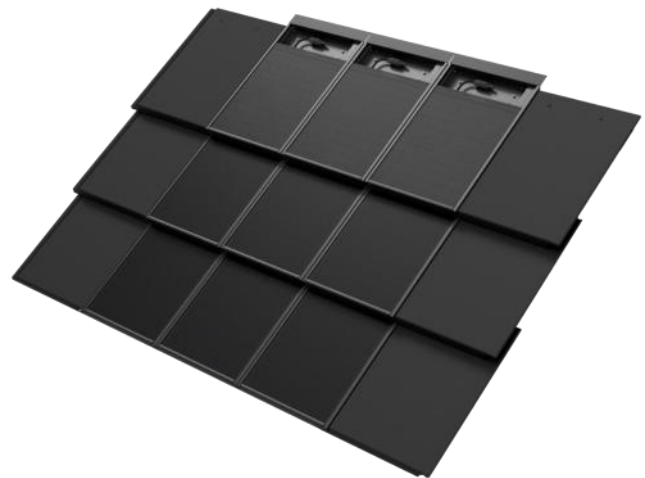

- › Complementary systems are available
- › Similar appearance to the SRT-MH
- › Wave profile to get a classic roof optic
- › Compatible roof steps to get easy on the roof
- › Snow guard modules provide receptacles for snow guard tubes

WAVE PROFILE



The desired design of the roof can be transformed into a classic roof with the wave profile. In this case, the modules are further apart and are connected by the aesthetic wave. The wave profile is designed in such a way that shading only occurs when the sun is very flat.



ROOF STEPS

Formed roof steps and snow guard modules complete the accessories. The roof steps are installed in place of solar roof tiles and provide a secure foothold for chimney sweeps, etc. For simple installation purposes, the integrated installation step is usually sufficient.

- › **Sheet metal package with roof steps**
- › **Optimal solution for chimney sweeps**
- › **Easy integration in the roof**



SNOW GUARD MODULES

For snowy regions, we offer snow guard modules that provide receptacles for snow guard tubes. In connection with the defrost function of the SRT-MH, slipping of so-called roof avalanches can be reliably prevented.

EXPLANATION: ROOF TILES

There are two different main types of roof tiles that are mostly common: Concrete and clay roof tiles. The clay roof tile is made of, as the name says, clay and is fired at high temperatures. Because of the raw material, there can be color changes within the product.

On the other hand, there is the concrete roof tile, which is made of concrete. Several color grades can be added to the concrete. Made with the extrusion moulding technology, the product is cheaper than a clay roof tile.

SOLAR FACADE ELEMENT MILD-HYBRID



With the universal Solar Facade Element (SFE), it is possible to easily open entire exterior facades for photovoltaic panels. The type of solar panel is irrelevant for the SFE. The system can be directly integrated into steel and concrete skeleton buildings. The minimal sloping position allows the facade elements to be covered vertically, enabling the replacement of individual panels and creating a visually uniform exterior surface.

ADVANTAGES

In addition to the universal mounting and the possibility of using PV panels from different manufacturers, the SFE directly forms the entire house facade system. With its sandwich construction, it is built like a wall element of a prefabricated house. Via different expansion stages, the SFE can be equipped as required with PV, thermal insulation up to the interior cladding including the cable ducts.



- › Universal mounting for external facades (BiPV)
- › Integration of any PV panels
- › Prefabricated wall element
- › Cooling of the solar cells through rear ventilation
- › Easy replacement of a PV panel from the composite possible

Behind the PV panels there is also an integrated air duct. This enables cooling of the PV modules via the chimney effect or natural convection, which protects the solar cells from degradation and rapid aging. The resulting waste heat can be fed into a heat pump via an extraction system, so that solar thermal energy is generated in parallel with the PV. In addition, the facade is kept warm in winter and cold in summer.

INSTALLATION

The installation is carried out on vertical beams, which form the basic framework in hall construction. The SFE is attached via screws that are initially exposed at the upper edge. After the PV panel has been pushed up, the two lower screws are accessible and can be screwed in. The PV connectors are located in the air duct, so that when the panel is pushed up, the vertically stacked panels can directly be connected. This can also be done after the entire facade has been installed.

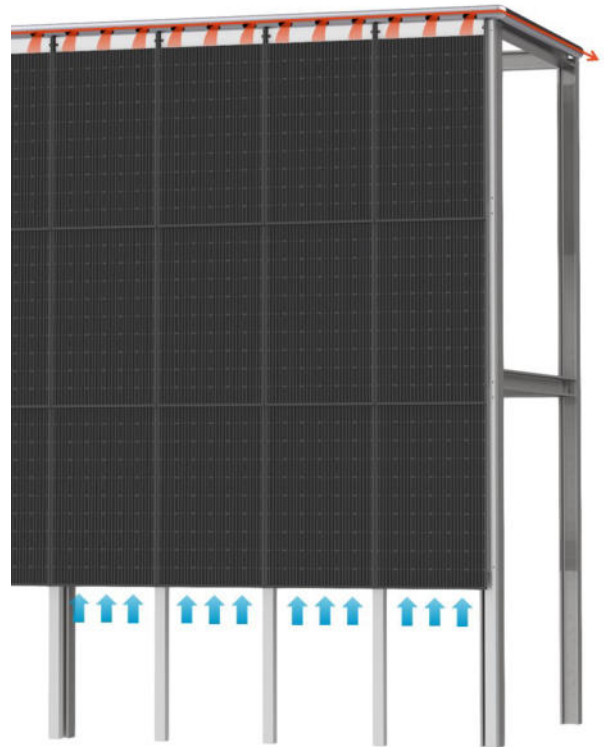

The PV module can be individually removed from the SFE. To do so, the panel is pushed upwards and the two lower retaining screws are loosened. This allows the SFE to be slightly angled and gives access to the screw connection of the lower frame. After this profile rail has been loosened, the PV panel can be removed.

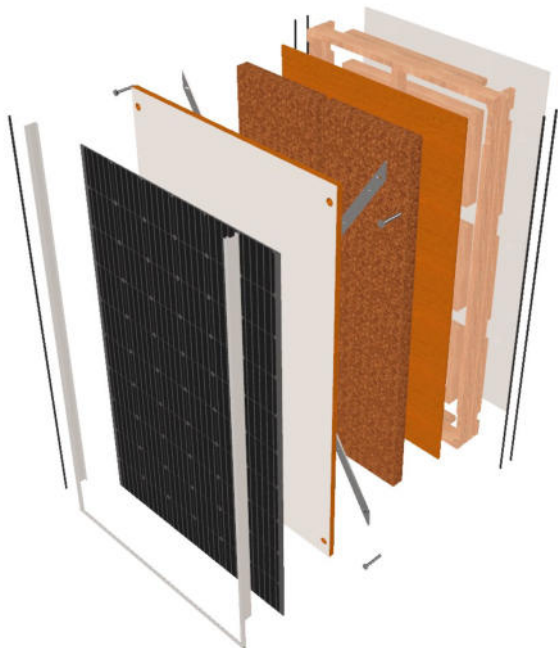

TECHNICAL DATA

Parameter	SFE-MH
Power Density	210W/m ² *
Color	Black*
Frame Material	Aluminum
Frame Coating	Powder Coating (all RAL Colors possible)
Dimensions (L x W x H) [mm]	1,700 x 1,000 x 105*
Expansion Stages	1. Basic: Panel and Static Support 2. With Building Insulation 3. With Cable Ducts and Inner Wall Cladding

* Depending on the selected PV panel

SOLAR WATER ELEMENT

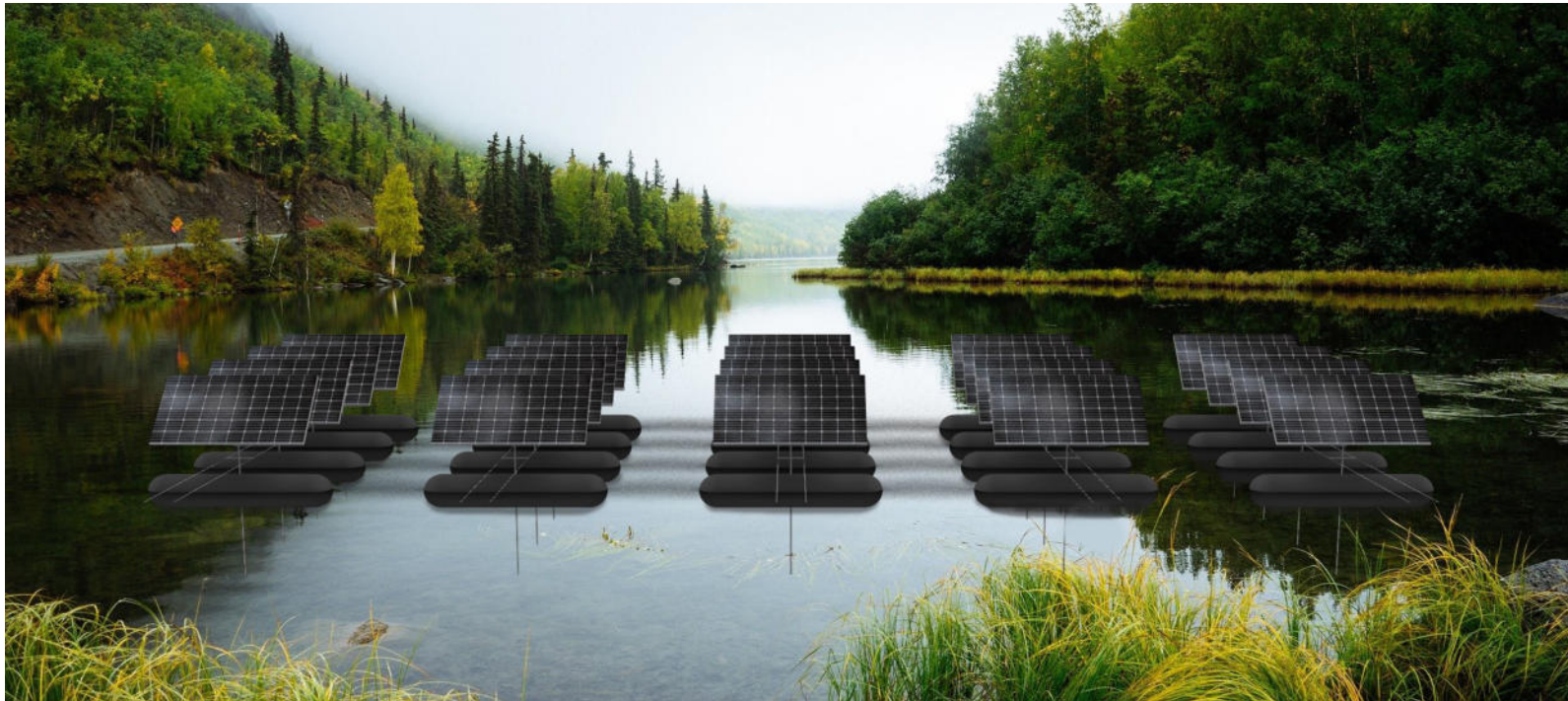

Water surfaces lend themselves to the use of photovoltaics due to their mostly unshaded location. Photovoltaic modules installed on water have a higher energy yield than comparable modules on land due to the reflection of the water and the solar radiation. At the same time, the water has a cooling effect, which also increases output.

Challenges exist in the active tracking of the solar modules and the mounting of the entire system in the landscape.

GENERAL FUNCTIONALITY

The PV panel is located on a frame equipped with a scalable float. On the frame are receptacles for wire ropes, through which the system can be controlled in rows. A node on the ground provides translational fixation in two directions.

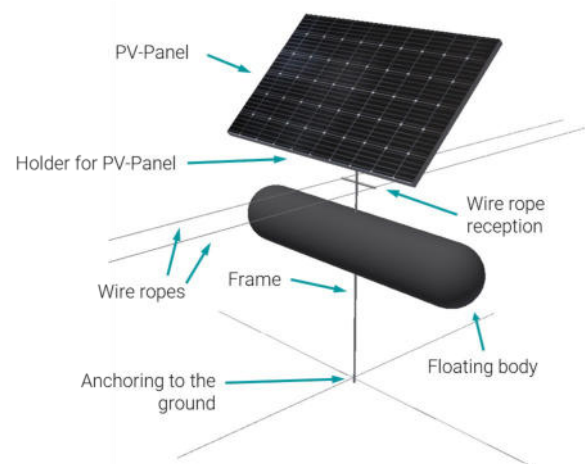

- › Universal mounting for PV panels on the water
- › Reflection of light, hardly any shading and cooling by the water increase energy output
- › Floating body provides buoyancy
- › Rotation and displacement are done by steel cables
- › Low motor power required as the whole system floats

CONTROL

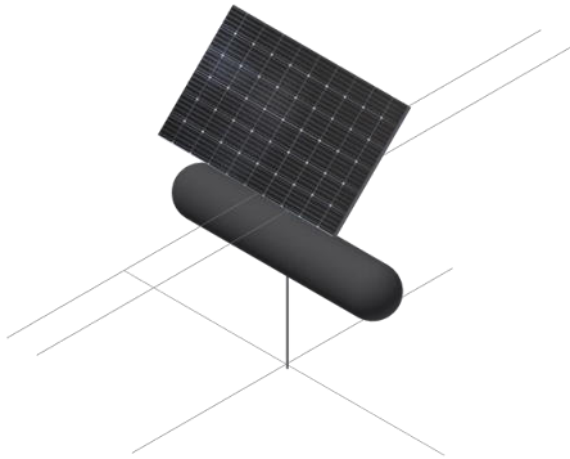

Initial State: The anchoring in the ground prevents floating away, the float provides sufficient buoyancy. The wire ropes connect and hold the entire system together.

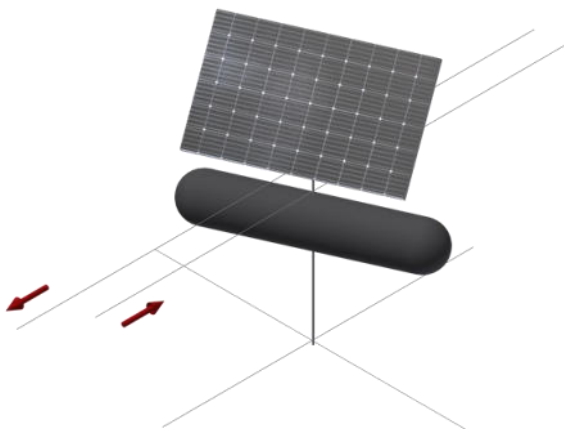

Rotation around azimuth: The wire ropes are pulled in opposite directions so that the PV panel can be optimally directed according to the course of the sun.

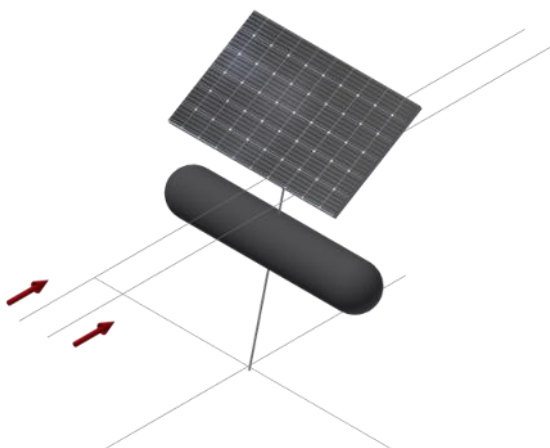

Rotation in elevation direction: When rotating around the abscissa, the wire ropes are pulled simultaneously. This allows the PV panel to always be positioned perpendicular to the sun. The motor power is only low in both cases, since the entire system floats. It is a 2-axis tracking system.

EXPLANATION: AZIMUTH

The azimuth is the angle between the south vector as a reference vector and the actual direction of the photovoltaic system in the horizontal plane.

In the northern hemisphere the azimuth angle corresponds to the directions 180° north, 270° east, 0° south and 90° west. In the southern hemisphere, the azimuth angle corresponds to 0° north, 90° east, 180° south and 270° west.

TECHNICAL DATA

Parameter	SWE-VG
Color and Power	Depending on Panel
Housing Material	Aluminum
Housing Coating	Powder Coating (all RAL Colors possible)
Floating Body	Plastic Blow Mold
Drive Type	Electric Motor
Control Type	2-Axis System
Dimensions (L x W x H) [mm]	1,850 x 1,000 x 105

SOLAR AGRICULTURAL ELEMENT FOUNDATION SYSTEM

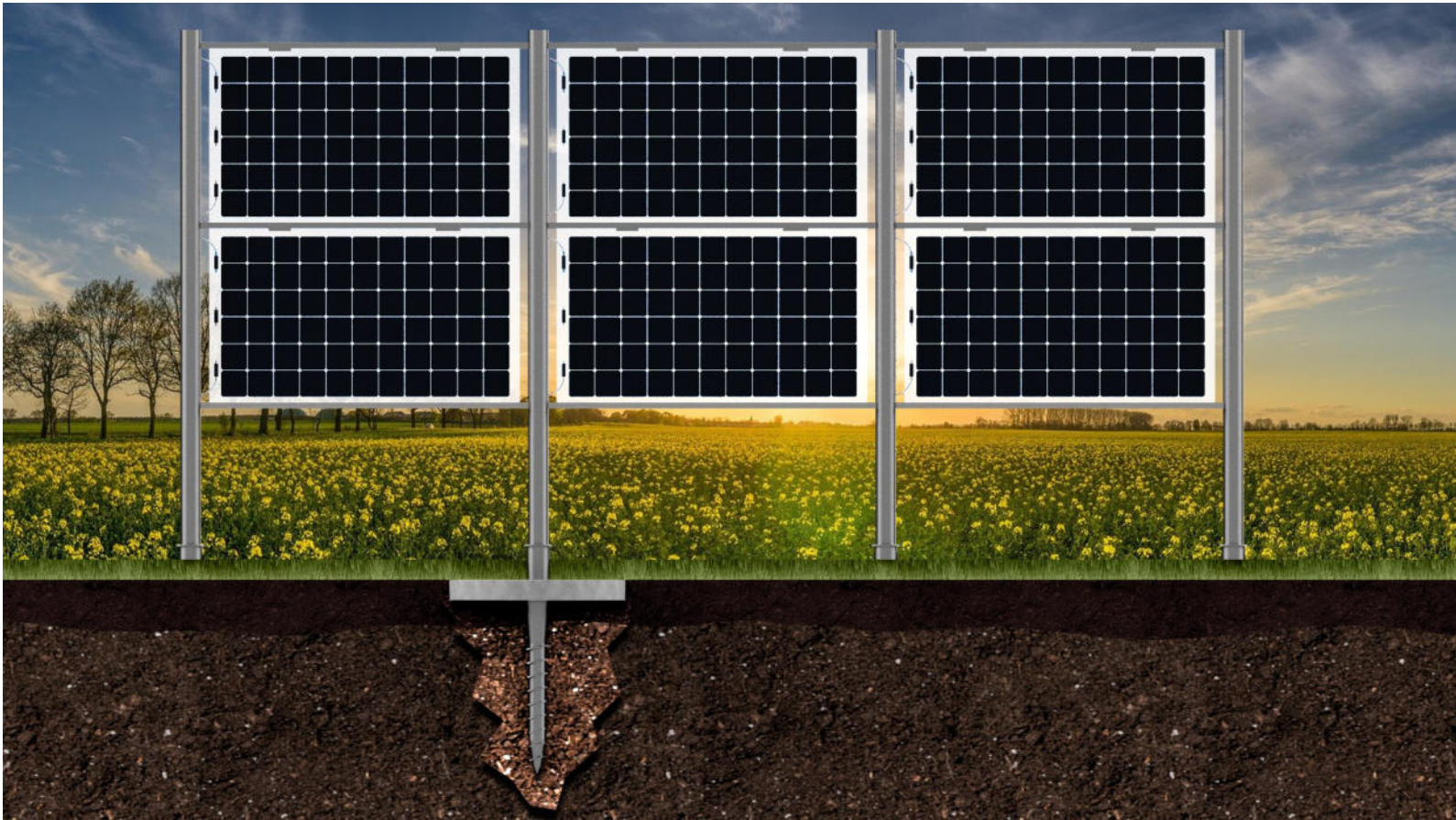

Agricultural systems allow farmers to make double use of arable land and increase land efficiency. The development of bifacial modules makes vertical installation in an east-west arrangement economically attractive to cover own needs with electricity generation as well as to protect semi-shaded crops from excessive solar radiation. In particular, vertical construction of Agri-PV promotes the need of foundation systems.

PROBLEM

High wind loads that occur on open land must be absorbed by the foundation and dissipated into the soil. This requires a high material input of concrete in conventional foundations. In addition to the increased material and in-



- › Universal foundation system especially for PV fences and ground-mounted systems
- › Secure mounting according to nature's tree root principle
- › Rapid installation and immediate loading possible
- › Easy to dismantle and reusable - no surface sealing and no pollutant entry into the soil

stallation costs, the ecological disadvantages such as soil sealing as well as the CO₂ footprint are also challenges that need to be solved.

SOLUTION

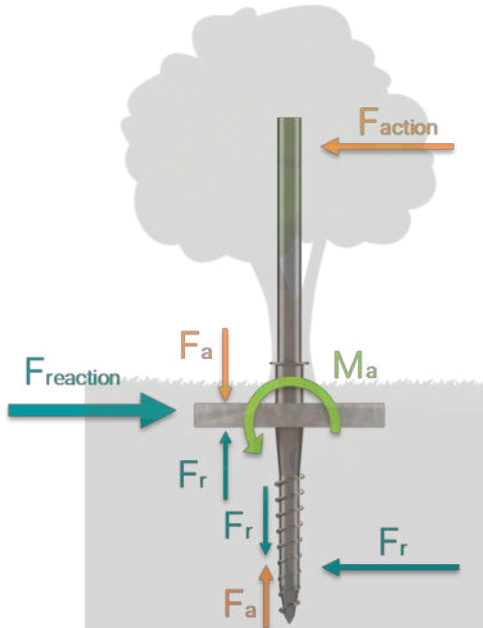

For the attachment of a fence post, the tree root principle is imitated. Central taproots absorb high tensile forces and surface roots absorb the bending and shear forces. The paXos foundation system is the combination of an earth screw, which absorbs the tensile forces, and a rigid concrete slab just below the turf, which absorbs the bending and shear forces.

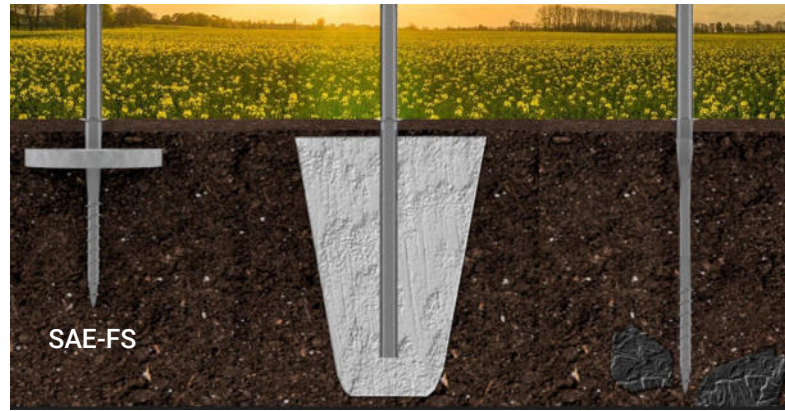
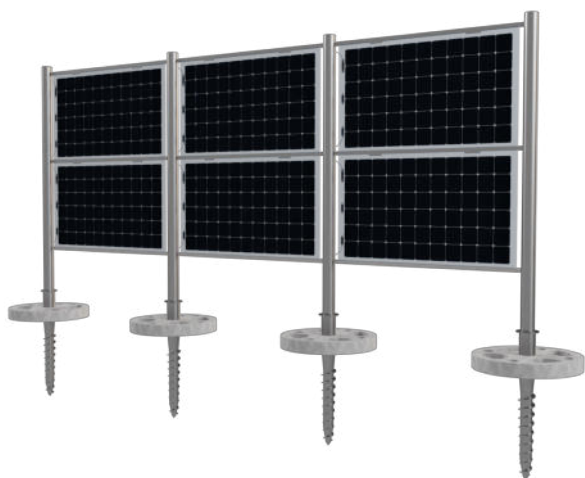

Figure: SAE-FS compared to conventional systems

ADVANTAGES

The foundation system from paXos enables cost-effective, quick installation with proven machines and techniques as well as immediate loading. Due to the derived tree root principle, higher bending moments can be introduced, which allows the construction of higher PV fences. In contrast to conventional systems, significantly less material is required, which is also easy to dismantle, so that areas are not permanently sealed and the environment is protected. No pollutants enter the soil, as is the case when in-situ concrete is placed, and larger stones in deeper soil layers are not a problem due to the shorter earth screws.

TECHNICAL DATA

Parameter	SAE-FS
Color and Power	Depending on Panel
Pole Material	Stainless Steel
Earth Screw Material	Stainless Steel
Compression Plate Material	Reinforced Concrete
Compression Plate Dimensions (D x H) [mm]	(500 – 650) x (80 – 100)*
Compression Plate Mass	40 – 50kg*
Variants	Variable Heights possible 1. One Row of Panels 2. Two Panels above each other

* Depending on the application and load case

SOLAR TRAFFIC ROUTE ELEMENT



Asphalted surfaces such as highways, roads, and parking lots are considered energy-inefficient surfaces. In addition, the asphalt is permanently exposed to extreme environmental influences, which can lead to damage to the pavement as well as aquaplaning.

The Solar Traffic Route Element (STE) enables these already sealed areas to be built over for the generation of PV and for the simultaneous protection of the asphalt. However, a superstructure of traffic routes falls by definition from a length of 80m into tunnel construction with higher requirements in terms of fire protection and air supply.

SOLUTION

A steel or reinforced concrete skeleton forms the basic framework of the STE, on which the brackets for the PV modules are mounted, which can be attached either overhead or lat-



- › Energy retrofitting of sealed surfaces such as highways, roads, parking lots, etc.
- › Simple steel skeleton construction
- › Rotatable PV modules allow fresh air supply and rapid smoke extraction as well as escape routes in case of fire
- › Integrated rainwater drainage prevents aquaplaning

erally. All modules are rotatably mounted and can be tilted as required.

ADVANTAGES

The rotatability of the modules enables rapid smoke extraction from the system in the event of a fire, so that no toxic fumes are generated in the tunnel. In addition, this system provides direct natural ventilation to meet the prescribed emission levels, eliminating the need for an additional ventilation system to supply fresh air. Furthermore, the ability of the STE's modules to rotate creates a possible exit or escape route in the side area at each PV panel. In contrast, escape routes in conventional tunnels are up to 500m apart.

The PV system of the STE provides absorption of the solar radiation, which creates a heat shield for the drivers and the asphalt. In addition, incoming rain is directly diverted, preventing dangerous aquaplaning. In case of heavy snowfall, the system can be relieved by tilting the modules.

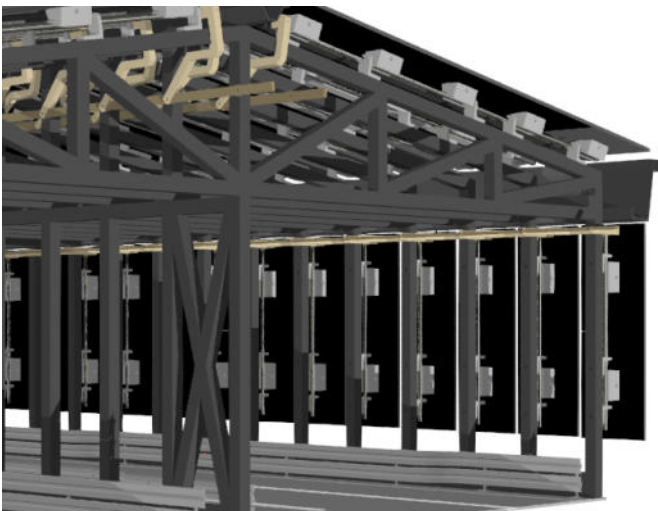

Figure: STE side view with opened PV modules

EXPLANATION: TUNNEL

Tunnels are traffic route elements that are built above-ground or underground. In Germany, above-ground enclosures with a minimum length of 80m are called tunnels as well.

Tunnel structures with a length of less than 80m are called underpasses. Every tunnel has to meet special safety requirements in terms of fire and escape routes.



TECHNICAL DATA

Parameter	STE
Color and Power	Depending on Panel
Construction Material	Mild Steel / Concrete
Dimensions (L x W x H) [mm]	Variable depending on Width of Lanes
Ventilation System	Integrated
Rain Drainage System	Integrated

SOLAR AUTOMOTIVE INTEGRATION



In case of vehicle-integrated photovoltaics, the available surfaces of vehicles have to be used reasonably for energy generation. The PV modules must be integrated into the vehicle mechanically, electrically and in terms of design, and must fit seamlessly into the vehicle shell.

The majority of automobiles are used for a short period of time during the day and are mainly stationary. During these periods, the vehicle can also contribute to the energy supply by producing electricity and keeping the interior of the vehicle largely cool. In addition to the exterior surfaces of the vehicle, such as the roof or hood, other surfaces can thus be used to generate solar energy when the vehicle is parked.



- › Use of vertical surfaces for improved yield in winter
- › Cooling effect by shading the interior in summer
- › The exterior of the vehicle is not changed
- › No impairment of the field of vision and crash safety
- › Solar modules are protected from external influences

SOLUTION

In the paXos concept, the window surfaces are equipped with solar cells that are mounted on retractable or foldable surfaces inside the vehicle. When parked, they automatically drive up or fold out and cover the window areas. The generated energy can be fed directly into the battery for usage. At the same time, the interior of the vehicle does not heat up significantly due to the additional shading.



FEATURES

While driving, the retractable PV modules of the side windows are retracted and hence not visible. The experience in the vehicle remains as before. Only when parked, the advantage of the solar modules is activated.

The sun visors fold up and cover the front windshield together with a module mounted above the dashboard. In the rear window area, a solar panel mounted on the parcel shelf folds up and covers the rear window.

ADVANTAGES

- › **Large window areas can be made accessible**
- › **Steady energy generation due to orientation of window areas**
- › **When driving, the PV modules are folded or retracted and not in view**
- › **When parking, the PV modules are folded out or extended**
- › **Retractable PV modules do not compromise the crash safety**
- › **Shading of the interior when parked reduces the required cooling capacity in summer**
- › **Use of crystalline or thin-film solar cells allow free shaping**

EXPLANATION: THIN-FILM MODULES

In contrast to crystalline solar cells, thin-film solar cells are made of amorphous or organic materials. The thin-film solar cells are vapor-deposited in wafer-thin layers onto a substrate material (e.g. break-resistant glass with a thickness of 1-2mm) and are directly interconnected in the process (integrated circuit).

The light-sensitive solar cell layer is only about 1-5 micrometers thick and thus about 100 times thinner compared to crystalline cells. This makes it easier to apply thin-film solar cells to uneven and curved surfaces.

JUNCTION BOX PV



In order to be able to use photovoltaic modules even more specifically and efficiently, we have developed our own junction box in a flat design for BiPV. The junction box is particularly suitable for small-format systems, as it offers performance optimization at module level. In this way, PV modules with different inclinations and orientations can be interconnected in one string, offering freedom in module alignment.

ADVANTAGES

The power optimization on module level includes a MPP tracking, which keeps each photovoltaic module in the range of the highest power. This leads to the maximum power output of the string.

The junction box offers the possibility of a safety shutdown at module level, which reduces the dangerous voltage in case of fire to the open-circuit voltage of each module. Since the DC main power lines are de-energized, there is no longer any danger to firefighters.

- › Flat junction box
- › Suitable for small format photovoltaic systems
- › Interconnection of PV modules with different orientations and inclinations
- › Power optimization at module level
- › Safety shutdown reduces critical voltage to the short circuit voltage of the module

TECHNICAL DATA

Parameter	Junction Box PV
Material	ASA
Dimensions (L x W x H) [mm]	67 x 75 x 15.7
Water Resistance	IP67
Cable	4mm ² , 0.47m
Connector	Sunclix
Mass	0.3kg

DON'T
WANT
TO
MISS
ANY
NEWS
IN
THE
FUTURE?



➤ HIGH PERFORMANCE CHARGING SYSTEM (HPCS)



With a reliable high performance charging system, the electrification of cars, commercial vehicles, ships and even aircraft is possible. To achieve broad acceptance, a short charging time (idle time) is necessary, especially in the area of commercial vehicles, as this is the only way to ensure economic efficiency. A high level of energy transmission between the power grid and the consumer is particularly crucial for this.

CHARGING PLUG COOL-LOAD MEGAWATT

In the future, the classic plug connection consisting of "pin & socket" will be one of the limiting factors within the charging infrastructure. With the charging plug "Cool-Load Megawatt", which has ring-shaped contact surfaces, the charging power can be adapted to future requirements simply by scaling the connector diameter. In this way, outputs of up to 40MW are possible.



- › High Performance Charging System for heavy duty vehicles (3 -12MW)
- › Very high efficiency: 99.74% at 5MW
- › Radial connection between plug and socket increases contact surface
- › Direct cooling of the plug and rinsing of the power cables in the charging cable
- › Flexible charging cable
- › Long service life (min. 100,000 charging cycles)

ADVANTAGES

1. Large contact area and small transmission distance

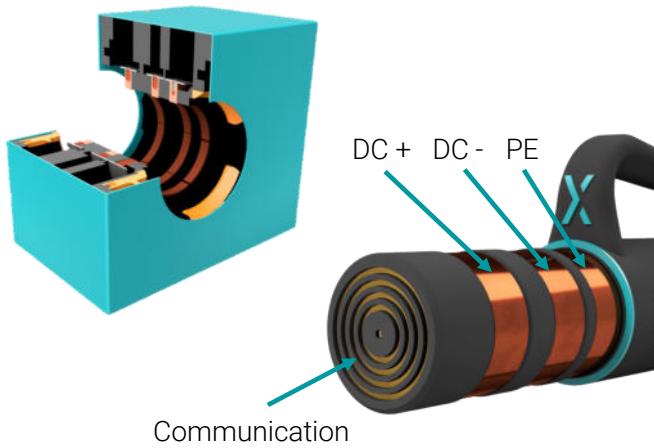

2. High contact pressure

The contact between plug and socket is made automatically. As a result, the insertion forces are low and the contact pressure during contacting is very high.

3. Grinding of contact surfaces

During the contacting process, the contact jaws close on the socket side and grind over the contact surfaces of the charging plug. This ensures that the surfaces always remain clean and the contact resistance is low.

4. Cooling of contacts and cable

The contact rings are located on a high-performance ceramic, through which the cooling fluid flows. This results in a very large heat transfer surface.

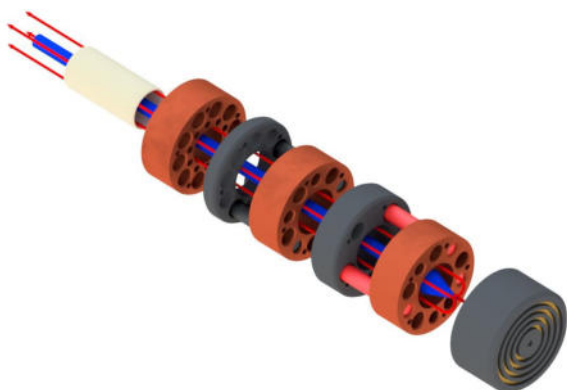

CHARGING CABLE

The division of the power cables into several small individual ones and the stranding of these individual wires results in a high flexibility of the charging cable.

In the center of the cable is the supply line for the coolant, which flows back between the individual, insulated cores. This provides excellent cooling and high flexibility of the cable.

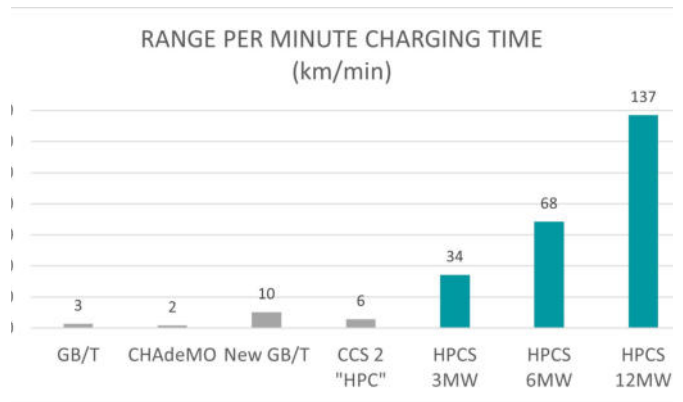
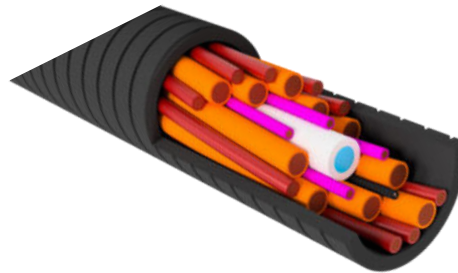

* For an e-truck with an average consumption of 167kWh/100km

TECHNICAL DATA

Parameter	HPCS 3 - 12MW
Power	3 - 12MW (dc 100%)
Nominal Voltage	1500V
Nominal Current	2,000 - 8,000A
Contact Area	5,300mm ²
Surface Pressure	> 100N with mechanical Connection System
Insertion Force	~ 0N
Handling	Orientationless Contacting
Cooling	Direct Contact Cooling

HPCS APPLICATION AREAS

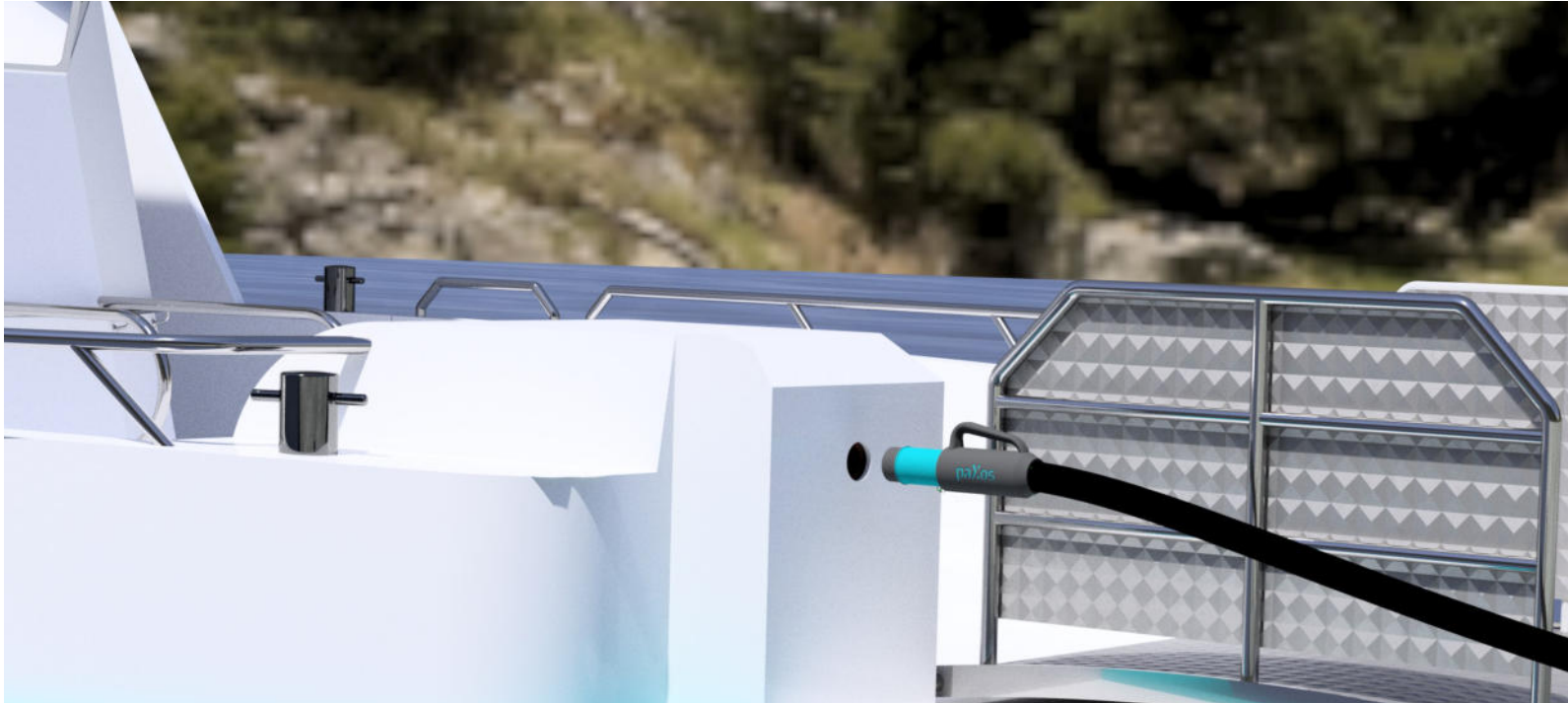

COMMERCIAL VEHICLES

Particularly in the commercial vehicle sector, charging systems that can transfer high amounts of energy in the shortest possible time are required. The aim is to supply the vehicle with the amount of energy needed until the next prescribed break during the legally prescribed driving breaks. This means that there are no additional breaks that lead to higher costs for the carriers and in this way negatively influence their acceptance of e-mobility. To achieve this goal, it must be possible to transfer an energy quantity of approx. 600kWh in 45 minutes.

SHIPPING & AVIATION

The maritime and aviation sectors are becoming increasingly electrified. However, there is currently still a lack of sufficiently mechanically protected systems that meet the increased requirements for contact reliability due to, for

example, strong waves or storms as well as increased air pollution due to salts or dust. In addition, very high amounts of energy are required in these areas, which can only be realized with current systems through long charging times or the use of multiple charging systems.

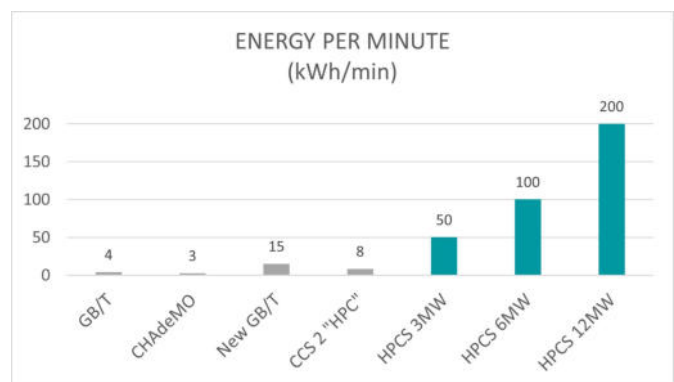

- › Scalability of the design enables charging power of up to 40MW
- › Protection of contact surfaces against salt water due to overpressure
- › Coolant transfer to the vehicle possible

CABLE BRIDGE

In the electrification of ships as well as in agriculture and aviation, it is essential for a reliable charging connection to mechanically secure the charging interface on the one hand and to relieve the charging cable, plug and socket on the other. Especially in the maritime sector, movements occur between the quay and the ship in all six degrees of freedom, which can be irregular.

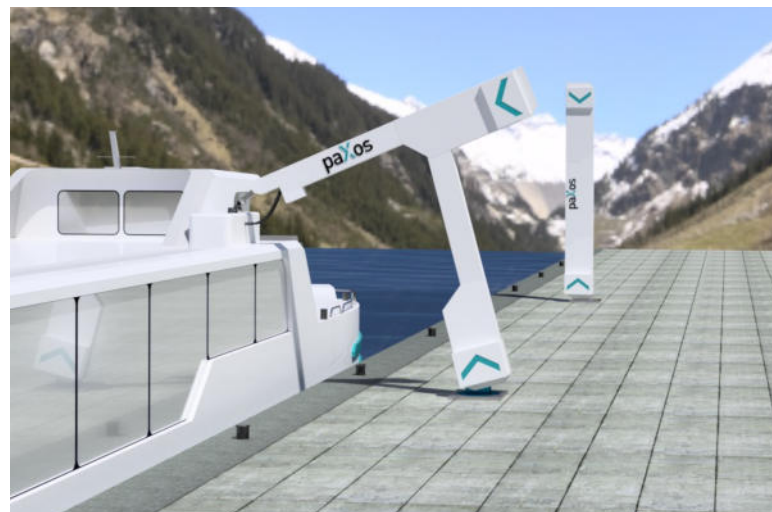

ADVANTAGES

- › Storage of charging cable and plug inside
- › Small footprint when folded up
- › Three-part construction with towing eyelet for extensive flexibility
- › Low forces required for movement
- › Pivoting arms above a height of 2.3m
- › Suitable for use in areas with special weather conditions
- › Easy maintenance access through maintenance flap

SOLUTION

The cable bridge provides a secure and at the same time flexible connection between a loading station and a vehicle, allowing relative movements. A towing eye is used to connect the cable bridge to the vehicle. Then the charging cable is connected to the charging socket located on the vehicle.

- › Secure and flexible connection of charging station and vehicle
- › Relief of charging cable, plug and socket
- › Slim design (foldable)
- › Easy to use

CHARGING DEVICE AUTOMATED

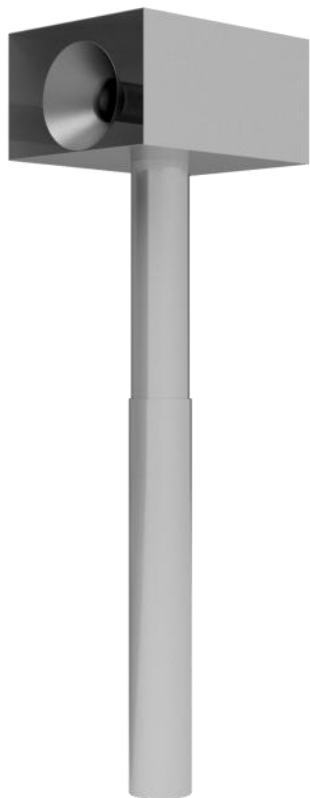
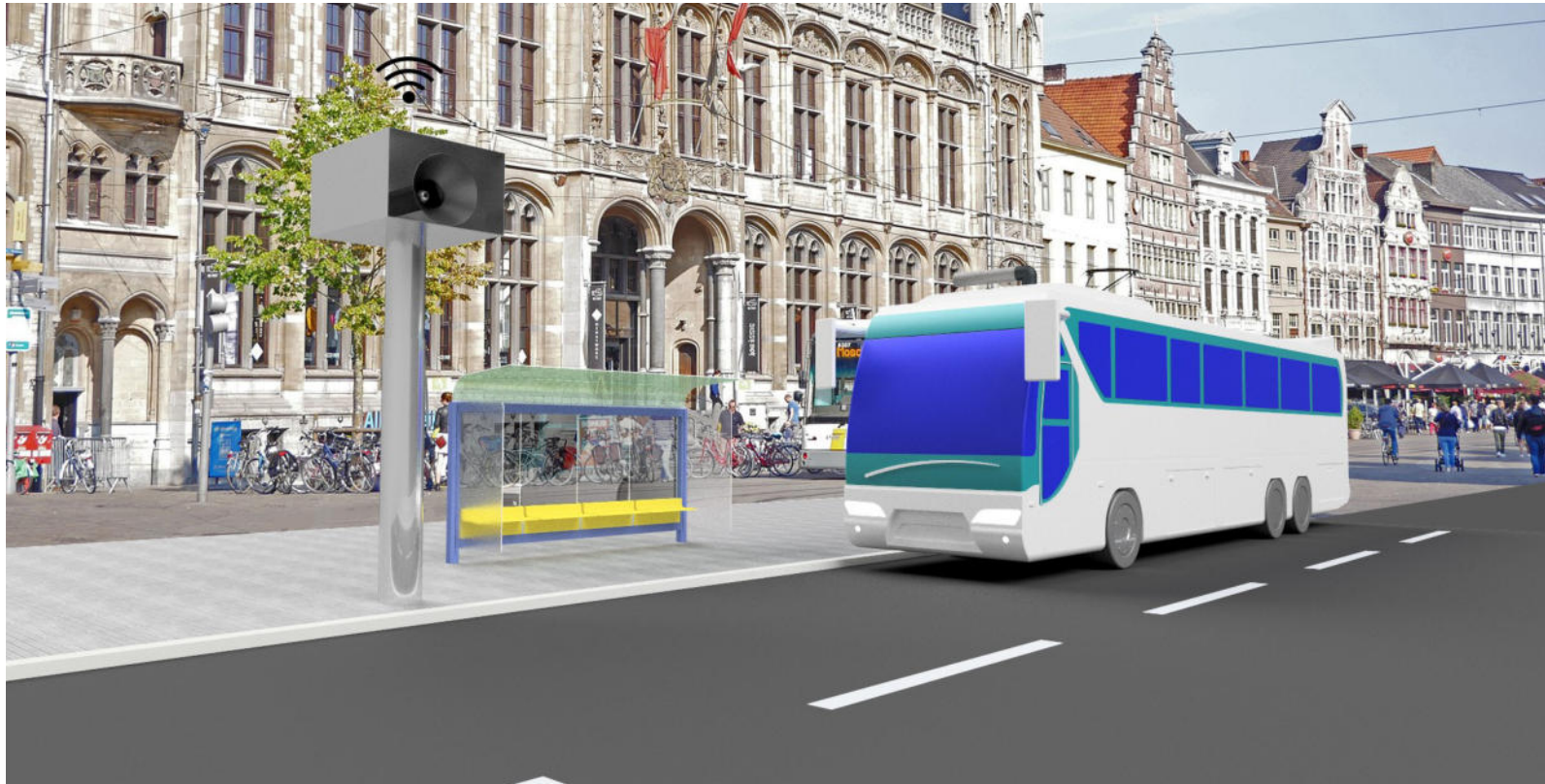

The electrification of commercial vehicles will increase sharply in the coming years. For this reason, the course must be set today to provide suitable technical solutions. Special requirements must be taken into account with regard to the necessary expansion of the charging infrastructure.

- › Customizable charging device for commercial vehicle sector
- › Automated charging process
- › Direction-independent charging of the vehicle (front right or left)
- › Safe accommodation of all essential elements in the charging pole
- › Safety of the commercial vehicle against swaying of the body due to loading and unloading or wind load

REASONS FOR THE DEVELOPMENT

The charging solutions currently available on the market have the disadvantage that heavy-duty vehicles cannot be charged reliably and safely. The dimensions of the charging cables and plugs continue to increase due to the higher charging capacities, so that manual operation will no longer be possible in the future.

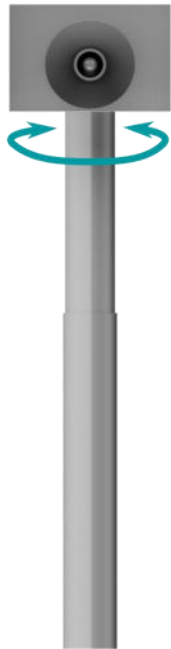
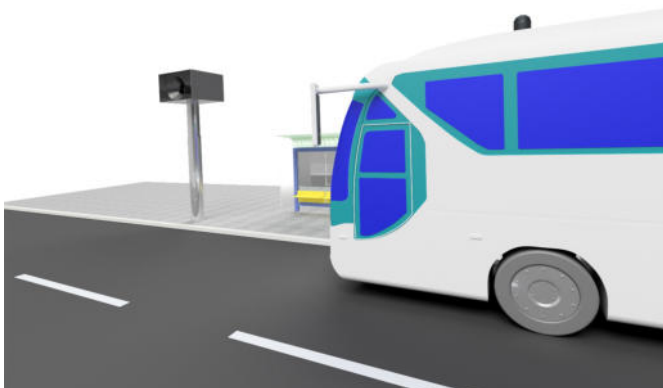

Figure: Adjustable charging device

ADVANTAGES

- › **Automated charging process for use in commercial vehicles**
- › **Direction-independent charging of the vehicle (front right or left)**



- › **Increased safety in the event of a crash**
- › **Mechanical safety against unintentional driving off (also accident)**
- › **Safety of the commercial vehicle against swaying of the body due to loading and unloading or wind load**

FEATURES

The automated charging device from paXos consists of a tubular stainless steel structure that protects against vandalism, with a flexible charging unit mounted on the upper end. This can be adjusted both in height and orientation. In this way, commercial vehicles can be charged largely independently of their standing position.

- › **Realization of fast charging systems possible**
- › **Contactless verification by mobile data systems (Vehicle-2-Infrastructure)**
- › **Safe accommodation of all essential elements in the charging pole**

EXPLANATION: V2I

Vehicle-to-Infrastructure is the wireless exchange of data between vehicles and the road infrastructure. V2I communication is wireless and bidirectional, the infrastructure provides the vehicle with various information.

TECHNICAL DATA

Parameter	Charging Device Automated
Power	Depending on Charging System
Dimensions (D x H) [mm]	300 x 3,500
Access Protection	Via Mobile Data / Vehicle-2-Infrastructure (V2I)
Cooling	Direct Contact Cooling possible

CHARGING POLE SMALL

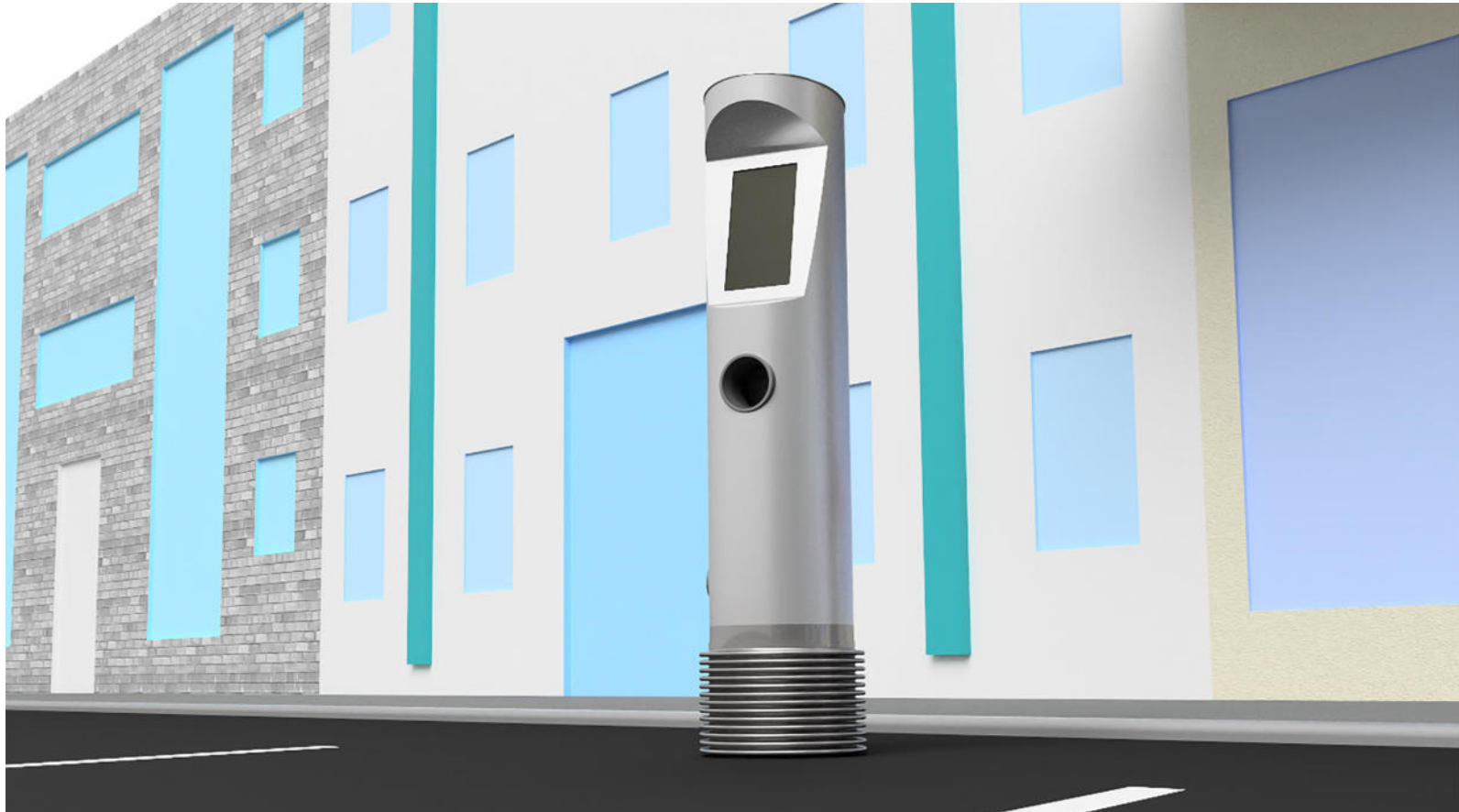

The expansion of the charging infrastructure is progressing worldwide and is placing ever new demands on charging points.

As the number of charging points increases, so does the risk of accidents due to crashes or parking bumps between vehicles and charging points. In such a case, the charging points are often replaced to ensure continued safety.

REASONS FOR THE DEVELOPMENT

The fact that this process is resource- and labor-intensive lowers the profitability for the providers of corresponding systems. In addition, damage occurs due to environmental influences and vandalism, which negatively affects customer loyalty.



- › Clean, slim and round design made of stainless steel
- › Robust against parking bumps due to patented predetermined bending point
- › Cables and plugs directly accessible from outside
- › Electrically sensitive parts independent of the ground
- › Compatibility with fast charging systems

ADVANTAGES

The small charging pole from paXos has a clean, functional design made of stainless steel that accommodates all the essential elements in the charging pole.

The large touchscreen enables easy operation, and individual operating systems can be easily integrated. Cables and plugs are directly accessible from the outside. Classic charging plugs or the paXos Cool-Load Megawatt can be used.

- › **Large touch screen**
- › **Safe accommodation of all essential elements in the charging pole**
- › **Electrically sensitive parts independent of the floor**
- › **Predetermined bending points at the bottom of the housing**
- › **Built-in parts accessible via top plate**

FEATURES

The round design in stainless steel makes it possible to minimize damage from parking bumps and vandalism. The cable and plug are released after successful authentication (RFID or cell phone call), and the charging connection to the vehicle can then be established.

For maintenance, the internal components can be accessed via the maintenance plate in the head, so that repairs can be carried out quickly.

EXTRACTABILITY

For the inconspicuous integration of charging points in city centers, the retractable version of the small charging pole can be used. This is equipped with an automatic lowering of the head unit for aesthetics and additional protection against vandalism.



- › **Touchscreen accessible after verification and extension for proper operation**
- › **Use with classic charging plugs**
- › **Robust housing**
- › **Maintenance access of the complete head unit**

TECHNICAL DATA

Parameter	Charging Pole Small
Power	Depending on Charging System
Dimensions (D x H) [mm]	300 x 1,200
Access Protection	Via RFID/Cell Phone
Cooling	Direct Contact Cooling possible

CHARGING POLE TALL

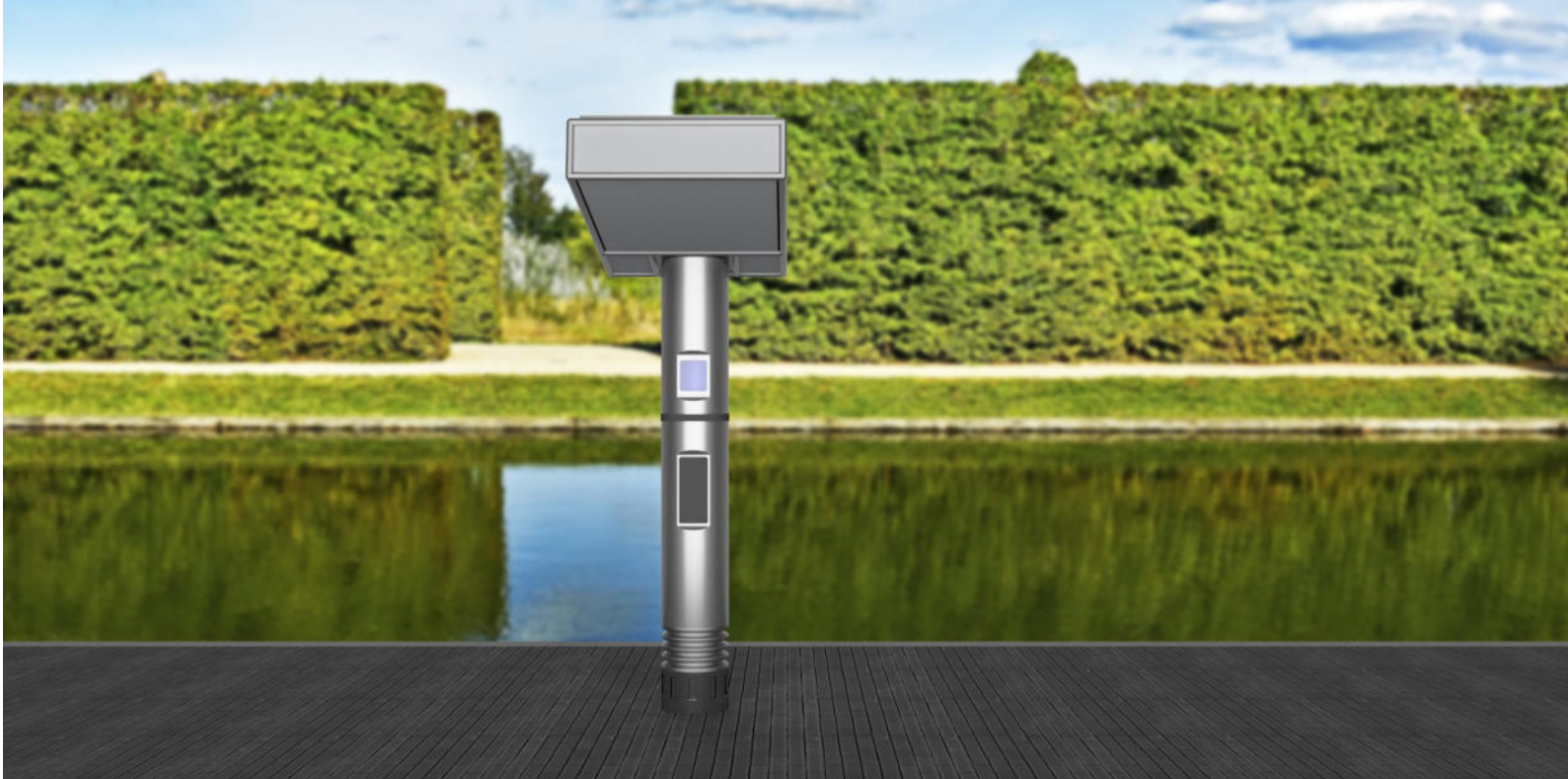

The expansion of high-performance charging infrastructure is progressing worldwide and is essential for reliable and resilient electromobility. Increasing the number of charging points as well as securing them in the event of a crash represent challenges that must be implemented promptly.

- › Round design in stainless steel
- › Charging unit securely housed in lid
- › Charging cable and display remain locked until authentication
- › Predetermined bending point at floor level in the event of a crash
- › Maintenance access for quick and easy inspection

REASONS FOR THE DEVELOPMENT

The charging stations currently on the market have the disadvantages that the charging cables are not integrated and are exposed to weather conditions during charging. In addition, significant weather events such as flooding pose the risk of permanent damage to the charging point.



Figure: Maintenance flap

ADVANTAGES

In the case of the large charging station, the cable and plug are locked in a column. After successful verification, they are released. The stainless steel column is strongly secured against vandalism and protected against scuffing, scratching or being stepped on.

All electrically sensitive parts are located above a height of 1 m above street level, so that they are secured in the event of a crash. A predetermined bending point at ground level ensures that the loading point is not damaged.



Figure: Direct access to the sensitive parts

- › **Integrated charging cable**
- › **Built-in parts easily accessible for maintenance**
- › **Roof with solar panel for rain protection**
- › **Predefined bending point on the housing**
- › **High protection against vandalism**

MAINTENANCE

The maintenance flap makes it easy to reach the installed parts and to replace them if necessary. The working height is ergonomically designed. Despite the easy opening for service work, the charging pole remains closed in the event of an accident and offers protection from the weather during operation.

TECHNICAL DATA

Parameter	Charging Pole Tall
Power	> 4,500kW (dc 100%) 350kW (CCS)
Nominal Voltage	1,500V
Nominal Current	3,000A
Dimensions (D x H) [mm]	300 x 2,500
Access Protection	Via RFID
Cooling	Direct Contact Cooling possible

WHEEL HUB MOTOR AXIAL SUSPENDED

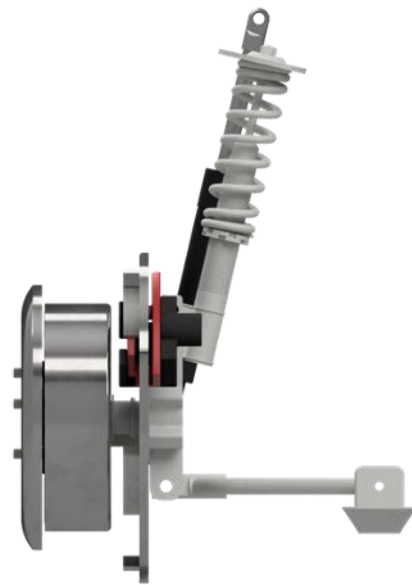

Wheel hub motors and near-wheel drives have not yet become established in the automotive sector. The reasons for this range from increased tire-sprung masses, which lead to a loss of comfort, to increased production costs.

From a driving dynamics and safety perspective, it is worth considering wheel hub drives. They lead to better driving performance and more precise control in critical situations - and in this way support the driver.

REASONS FOR THE DEVELOPMENT

paXos has set itself the goal of thinking sustainably - also for drives in vehicles. We are developing a state-of-the-art machine that creates space inside the car. The engine, clutch and transmission are reduced to a single unit that is inconspicuously integrated into the installation space of the rim. A patented axially

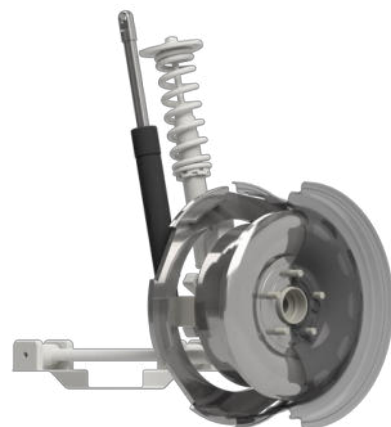

- › Axially arranged, switched reluctance machine
- › High efficiency in the partial load range
- › Reduction of tire-sprung masses due to suspension of the stator
- › No use of rare earths required
- › Cost-effective production possible

arranged switched reluctance machine is used, which uses the reluctance force to set the rotor in motion.

SETUP

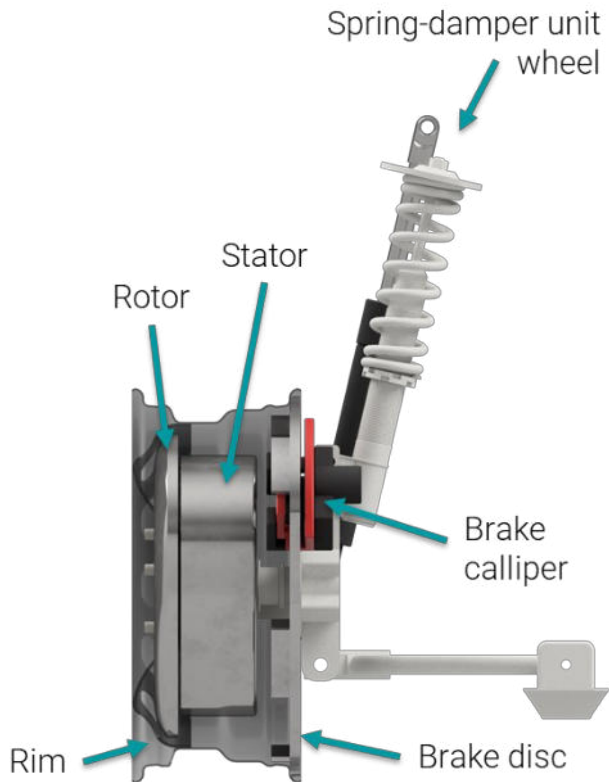

SPECIFICATIONS

- › Novel design as axially switched reluctance machine (GRM)
- › Inconspicuously integrated in the rim
- › Simplified design, low-cost production
- › External brake disc
- › Reduction of tire-sprung masses thanks to separate spring-damper unit for the stator
- › McPherson / multi-link

FEATURES

Unlike other electric motors, a switched reluctance machine does not require rare earths. Since both the stator and rotor have no permanent magnets, they have lower losses and a lower weight, compared to PMSM.

The separate suspension of the stator leads to advantages in terms of driving dynamics, since the stator is no longer tire-sprung. In addition, depending on the voltage level of the battery, only a DC / DC conversion is necessary.

EXPLANATION: RELUCTANCE FORCE

The reluctance force is based on the change of the magnetic resistance so that it is always minimal. A Switched Reluctance Machine (SRM) generates a changing magnetic field via windings in the stator. The rotor moves in such a way that the magnetic resistance is minimized.

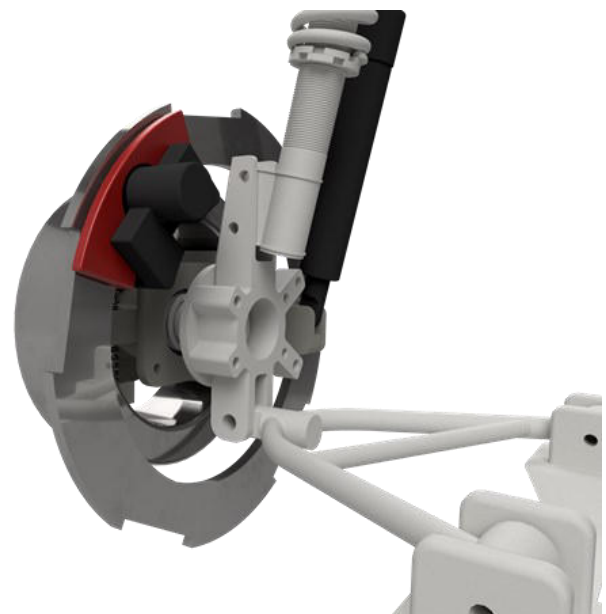

TECHNICAL DATA

Parameter	WHM-AS
Power	50kW
Mass	35kg
Rim Size	17inch
Suspension	McPherson, Multi-Link, separate Spring-Damper Unit for the Stator
Brakes	External Brake Disc

RAPID FOUNDATION SYSTEM



Secure anchoring in the ground is essential in many applications. Factors such as soil conditions and occurring loads (e.g. due to wind or snow) must be taken into account. In addition, safety factors must be included, so that a conservative design is usually used.

PROBLEM

To ensure such a secure anchorage, large-scale concrete foundations are poured. In addition to high costs for materials and labor, this also results in disadvantages from an ecological point of view. The concrete foundations remain in the ground after use or can only be removed with great effort - the ground is sealed.



- › High bending and compressive rigidities enable larger superstructures
- › Imitation of the tree root principle by combination of earth screw with shear-compression-bending plate
- › Fast installation and immediate loading possible
- › Environmental protection due to residue-free deconstruction
- › Less material used than with conventional concrete foundations

SOLUTION

To ensure secure fastening in the ground, the tree root principle is imitated. By combining an earth screw inserted into the ground with a rigid precast concrete slab, high bending and compressive rigidity can be realized. In this way, wind and weight loads from superstructures are reliably diverted.



Installation is carried out using tried-and-tested methods. The earth screw is a widely used product, so that inexpensive machines for screwing it in are already available. Excavation of the soil layer for insertion of the rigid precast concrete slab is also simple and cost-effective.

Conventional mounting systems rely on the production of concrete on site or large machines for driving the posts into deep layers of soil. In comparison, the paXos Rapid Foundation System eliminates the waiting time and multiple on-site operations that result from the setting time of in-situ concrete.

USE CASES

The Rapid Foundation System developed by paXos is a sustainable anchoring solution for a wide range of applications:

- › **Large umbrellas**
- › **Traffic signs and lights**
- › **Masts (radio, antennas, floodlights)**
- › **Advertising boards**
- › **Ground-mounted PV systems and fences (see p. 18)**
- › **Foundations for containers and prefabricated buildings**
- › **Sound barriers**
- › **Guard rails**
- › **Charging stations**
- › **Wind turbines**

TECHNICAL DATA

Parameter	RFS
Dimensions (D x H) [mm] Concrete Plate	(500 – 650) x (80 – 100)*
Mass	40 – 50kg*
Fire Behavior	Fire Protection Class A1
Harmonized Norm	DIN EN 1339
Raw Density (Average)	2.3kg/dm ³
Breaking Load Class	Class 3
Bending Tensile Strength Class	Class 2 (T)
Frost Resistance / Weather Resistance	Class 3 (D)
Moisture Expansion	None

* Depending on the application and load case

COMPANY

We look forward to the personal contact with you - be it as a future customer, employee or partner. Engineering services, project management and consulting are our passion, whether in small orders or large development projects. We are particularly strong in the cross-system challenges and can therefore handle projects holistically. We are looking forward to a sustainable and good cooperation in exciting projects.

We support you in your planning and questions in the areas of energy technology, automotive and industry. With our innovative in-house developments such as the solar roof tile or the charging plug, we are preparing for the future. Interdisciplinary execution of orders is our strength. The know-how flows in from all industries and areas to make your project successful.

PAXOS IS DIFFERENT

- › We are self-financed.
- › We are focused on sustainability.
- › We are a real team & act like one.
 - › We live flat hierarchies & can therefore act / decide quickly.
- › We are lean & dynamic.
 - › We are experts: tech-savvy, highly innovative & at the same time solid business people.



www.paXos.gmbh

HARD FACTS



Company:

- › founded in 2015
- › over 25 years of joint experience
- › self-financed
- › sustainable orientation
- › flat hierarchies / quick decisions
- › lean and dynamic

Key areas:

- › Engineering/Technical Services/Consulting
- › Project Management for small and large projects
- › Commercial Services and Consulting from one source

Excerpt of some customers:

CJ Automotive, Continental, Ford, Hoberg & Driesch, Knorr-Bremse, Magna, Meyer Burger, Porsche, ProGroup, RheinEnergie, Stadtwerke Iserlohn, Standard Profil, Webasto



www.paXos.solar

SERVICES

We develop state-of-the-art solutions for our customers at our site in Langenfeld (Rhld.) and offer not only consulting and services, but also product realizations up to prototypes.

With three key industries we bring a lot of expertise and know-how from a variety of projects. Synergies can be found not only in engineering, but also in cross-industry topics such as consulting, project management, training and human resources management.

- › **Analysis:** Problem Structuring, building process landscapes and maps, identification of possible weak points, planning of concrete measures
- › **Improvement:** Elaboration of concepts, support in decision making, monitoring, realization of individual solutions
- › **Control:** Final analysis to evaluate the solution, follow-up, lessons learnt

CONSULTING



With our excellent consulting, we provide you with individual solutions for your technical and economic problems. Based on your strengths, we develop tailor-made concepts for you that enable you to be even more successful. Whether by adding to your range of services or adapting to the specific customer - goal: a sustainable and profitable business.

- › **Definition:** Analysis of the specific situation (problem and scope), definition of the project outcome, creation of work plans
- › **Measurement:** Data collection, determination of the actual situation, definition of measurement criteria

THINK TANK



We not only advise, we have become an important player in the market in the field of innovation with a large number of patents, our own prototype workshop and testing facilities. In this brochure you will find many examples of how we set trends in innovations. We help you to identify precisely these trends for your company at an early stage and to implement them in appropriate products. Our focus is on the automotive and energy sectors, in particular renewable energies and electromobility.

ENGINEERING



Whether as support for your company on site or as a complete development project for you at our location - we offer you a wide range of cooperation options. If you need a component adaptation or a complex overall development - our team will be happy to convince you with its competence. We are also happy to represent your company in the development teams of large OEMs - we have the know-how that makes you successful.



We offer you a broad portfolio of engineering services from component / system support, CAD design and CAE calculation to resident engineering and electrics / electronics development through to testing.

- › **Concept creation:** Status analysis, package studies, strategy development, construction sketches
- › **Construction:** Data conversion and maintenance with CATIA V5, Inventor as well as

the databases Teamcenter and Vault, 3D-modelling according to specifications, 2D drawing derivation according to customer standard, component design and optimization

- › **Simulation & Calculation:** Durability and strength, acoustics, fluid mechanics CFD, 3D optimization with CAESSES Mantium Flow
- › **Prototyping:** Small parts from plastic and metal, own workshop with extensive tools and machines, rapid prototyping
- › **Test & Validation:** Define test conditions, test coordination and execution, preparation of measurement results and analyses

PROJECT MANAGEMENT



We offer you a comprehensive package in the area of project management from the first planning to commissioning and beyond. Everything from a single source, competent and reliable. With a wide range of project management know-how, a high level of motivation and experience from other industries, we react flexibly to situations and think sustainably.

Everything "new" in your company - new production facilities / products / processes / software etc. - is implemented through projects, which come to you as additional tasks. The implementation of projects, project management, is therefore one of the most important success factors for your company.

- › **Initialization:** Feasibility study, preparation of initialization, definition of project scope and objectives, (project) communication, approval procedures (BlmSchG)
- › **Planning:** Project definition, risk management, scheduling and coordination, budgeting, contract design and tracking, contract negotiations
- › **Execution:** Cost and performance control, determination of deviations (target-actual), report management, claim management
- › **Commissioning:** Progress tracking, critical path analysis, project control, construction and installation supervision, quality control

The paXos project management team is specialized in advising, accompanying and supporting you in your projects. Our employees have the following project management certifications: PMI / Prince2 / GPM IPMA. Together with you we realize your projects for a successful future of your company.

TRAINING



As a consulting company, we train almost all areas that are also offered as a range of services. From Engineering, CAx, PLM and Project Management to soft skill and office automation training: Let us convince you of our diverse offering!

- › **Technical Trainings**
- › **Project Management**
- › **MS Office**
- › **Soft Skills**

Our trainers and speakers have years of training and professional expertise and will be happy to develop individual training concepts tailored to your specific needs.

HR CONSULTING



Thanks to our years of experience in recruiting for our major clients and in developing successful employer brands, we can provide you with comprehensive support in establishing successful HR concepts, strategies and processes.

As employers, companies are more than ever exposed to constant competition for the best employees. An attractive overall HR concept is indispensable for successful recruitment and long-term loyalty to the company. The various HR topics are closely intertwined, so that they can only lead to the greatest possible success if they are combined.

JOURNEY DIRECTIONS



ARRIVAL BY CAR

Coming from the North

- › Take the A59, direction Cologne / Leverkusen
- › Leave the motorway at the exit 24 - Richrath and turn left at the traffic lights onto Berghausener Str.
- › Turn left at the next traffic lights onto Karl-Benz-Straße

Coming from the East, South and West

- › Take the A59, direction Düsseldorf
- › Leave the motorway at the exit 24 - Richrath and continue straight ahead at the traffic lights onto Karl-Benz-Straße

Further Route

- › Turn right at the first intersection and follow the road
- › The building is on the right hand side, parking spaces are on the right hand side behind the building

ARRIVAL BY PUBLIC TRANSPORT

From the Airport

- › From Cologne/Bonn airport, take the S-Bahn (suburban train) lines 12, 13 or 19 to Cologne Central Station. Take the S6 in the direction of Essen Hbf.
- › From Düsseldorf airport, take the S-Bahn line 11 or the RE lines 1 or 5 to Düsseldorf Central Station. Take the S6, direction Köln-Nippes or Köln-Worringen.

- › Exit the train at „Langenfeld-Berghausen“ and walk about 350 meters

From the Main Station

- › From Cologne Central Station, take the S6 towards Essen Central Station
- › From Düsseldorf Central Station, take the S6 towards Köln-Nippes or Köln-Worringen
- › Exit the train at „Langenfeld-Berghausen“ and walk about 350 meters



IMPRINT

paXos Consulting & Engineering GmbH & Co. KG
Karl-Benz-Str. 9
D-40764 Langenfeld

REGISTER ENTRY

Entry in: Commercial Register
Register Number: HRA 24870
Register Court: District Court Düsseldorf

Represented by

paXos Management GmbH
Karl-Benz-Str. 9
D-40764 Langenfeld (Rhld.)

Entry in: Commercial Register
Register Number: HRB 82997
Register Court: District Court Düsseldorf

Professional Representation

Peter Hakenberg, Managing Director
Janina Kaergel, Managing Director
Karsten Birkholz, Authorized Representative
Guido Schumacher, Authorized Representative
Stefan Puczynski, Authorized Representative

CONTACT INFORMATION

Telephone: +49 (0) 2173 200 43 30
E-Mail: info@paXos.gmbh

VAT NUMBER

VAT identification number in accordance with
§27 a of the German VAT act: DE299685862

paXos

paXos Consulting & Engineering GmbH & Co. KG



Karl-Benz-Str. 9

D – 40764 Langenfeld (Rhld.)



+49 (0)2173 200 43 30



info@paXos.gmbh



www.paXos.gmbh



www.paXos.solar